

NextLink

Solar-Powered Connectivity

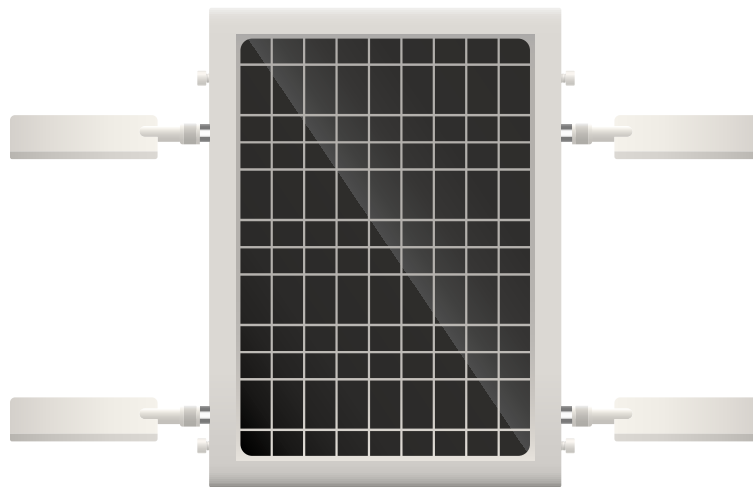

The [NextLink \(NL4\)](#) is the ultimate all-in-one solar-powered Gateway and Repeater. Featuring the fastest charging and longest-lasting battery in its class, the NextLink ensures seamless connectivity with the simplest deployment.

Flexible Deployment

Recognizing the critical need for reliable connections, especially in areas with limited power and network access, we have designed the NextLink to integrate effortlessly into diverse environments.

The NextLink's all-in-one design combines an efficient solar panel, a high-capacity battery, and powerful radios, enabling installation in virtually any location—regardless of wired power or network infrastructure availability.

Extending Communication

NextLinks work seamlessly together to extend your wireless meter network even into areas outside of cellular coverage.

Powerful external antennas ensure reliable communication for meter points spread over long distances as well as in high-density submetering applications.

Sustainable Longevity

Built with a robust cast-aluminum housing and fully waterproof design, the NextLink is engineered to withstand even the harshest conditions. Through rain or shine, the NextLink delivers connectivity using renewable solar power, making it both a practical and eco-friendly fixed-wireless solution.

Key Benefits

- Built-in 5G LTE cellular
- Operates as a Gateway and Repeater to expand coverage
- Fully recharges with only 6 hours of full sunlight
- Efficient power management provides up to 7 days of operation without sunlight
- 2-way meter communication
- High-gain external antennas for extended range
- Battery will continue to charge in freezing temperatures
- IP-68 rated for outdoor use
- All-in-one unit eliminates the headache and problems associated with piecemeal kits

Warranty

- 5-year standard warranty



Specifications & Installation Guide

Specifications

Dimensions

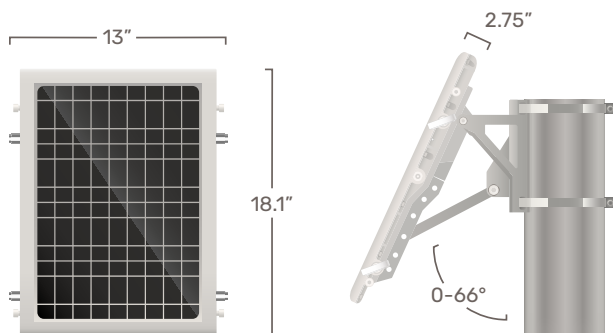

Approvals

- FCC ID: 2A8EC-NL4
- IC ID: 28950-NL4
- Contains FCC ID: 2ANP000NRF9151
- Contains IC ID: 24529-NRF9151

Communications

- 5G LTE cellular with simple no-contract subscription
- Easy mobile app configuration
- Built-in NextConnect receiver for meter communication
- Seamlessly operates as a relay to extend network

Data

- AMI solution, continuous meter communication
- Mobile and web access for configuration and monitoring
- Supports detailed utility usage history

Power

- Solar-powered, integrated 15W panel
- Built-in ESD protection for lightning protection
- High capacity rechargeable battery
- Supports operation through extended low-light weather
- Field-replaceable battery

Temperature

Operation from -40°F to 140°F | -40°C to 60°C

Environment

- Engineered for long-term outdoor durability
- Compact design, industrial quality cast aluminum
- Weather-resistant construction, IP-68 rated
- Designed to withstand strong winds and harsh conditions

Installations

- Accessories included for pole, wall, or roof mounting
- Mobile app guides optimal solar panel positioning
- Simple LED status feedback

Warranty

Next Meters warrants the NL4 to be free from defects in materials and workmanship for a period of five years from date of manufacture when installed in accordance with these instructions and with limitations as detailed in the complete warranty.

docs.nextmeters.com/warranty

Due to continuous product improvement and the need to comply with evolving regulations, Next Meters reserves the right to modify product specifications without prior notice.

Contact

For additional information or assistance, please visit our Support Center or contact our Product Support Team:

support.nextmeters.com

(844) 538-8203 | support@nextmeters.com

Specifications & Installation Guide



Installation

Full Package Contents

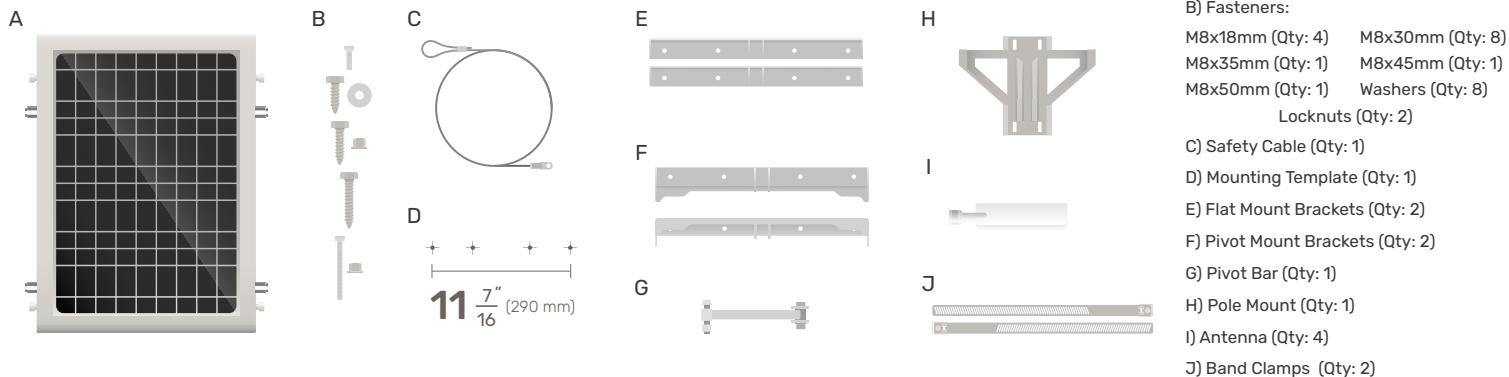

Qualifying Installations

The NextLink should be installed in an orientation and location that maximizes the solar panel's ability to charge the device.

Choose a location with clear lines of sight to the sky year-round. When using a mount that allows you to adjust the angle, choose an angle that will allow the panel to face the sun directly at midday.

Where possible, the NextLink should be installed no less than 10 feet (3 meters) from the ground. Higher installations are generally preferred. Use a stable ladder when necessary. Take appropriate safety precautions.

For latitudes that experience significant variations in the position of the sun between seasons, you should angle the panel to face where the sun would be in the winter.

In locations where snow is expected, flat mounting is not recommended. The buildup of snow on the solar panel will disrupt device charging.

The NextLink mounting systems are designed to withstand significant environmental pressures. However, it is vital to complete the installation process, **including the installation of the safety cable**, to ensure protection of persons and property in the event of mounting system failure caused by extreme weather.

Failure to follow these instructions may cause you to forfeit the protections guaranteed in our warranty.

Required Tools

To install the NextLink, you will need the following:



Drill with 1/4" Drill Bit



Pencil



Adjustable Wrench

Mounting Options

NextLink can be mounted three ways: Wall Pivot, Pole, or Flat Mount. All required hardware (besides tools) for each option is included in the box.

Installation: Wall Pivot Mount

Using the pivot mount side of the included drilling template, mark the holes for the mounting hardware on the surface where the device will be mounted.

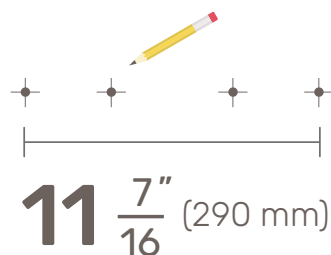

Drill the holes using a 1/4" drill bit.

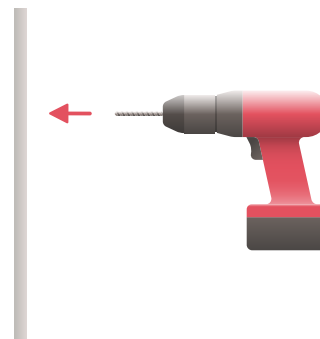

Specifications & Installation Guide



Installation (cont.)

Using the holes drilled in the last step, attach the brackets to the surface using eight (8) M8x30mm lag bolts and washers. You will use four (4) bolts/washers per bracket.

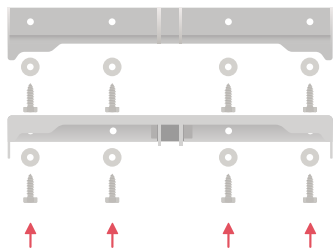

Attach the top of the NextLink to the top mount bracket using two (2) M8x18mm socket head cap screws. At this stage, these screws should be hand tightened.

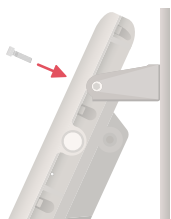

Attach one end of the pivot bar to the center mounting location of the lower mount bracket using the M8x35mm bolt and an M8 locknut. At this stage, these fasteners should only be hand tightened.

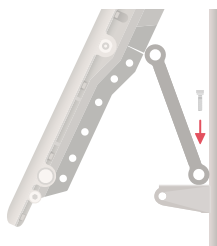

Attach the opposite end of the pivot bar to the NextLink. Choose the appropriate set of holes in the center of the NextLink to optimize the angle of the solar panel (relative to the sun). Use the M8x45mm bolt and M8 locknut.

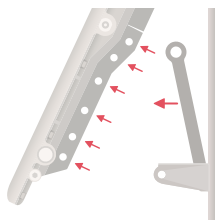

Once the appropriate angle is achieved, use a wrench to tighten all bolts connecting the NextLink and mounting hardware well beyond hand tight to ensure a secure connection. Do not use excessive force, which can result in over-tightening.

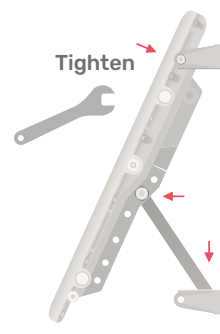

Attach the safety cable to a solid mounting point near the NextLink. Then remove one of the M8x18mm screws and use it to bolt the end of the safety cable to the mount bracket and the NextLink.

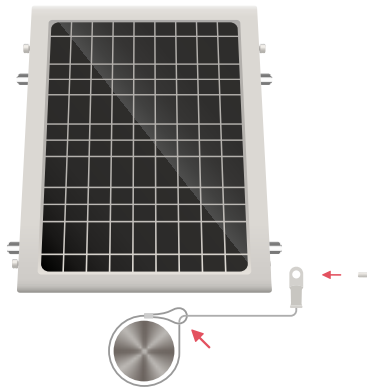

Attach the antennas by hand tightening them to the connection points on the sides of the NextLink. Any antenna can be connected to any connection point.

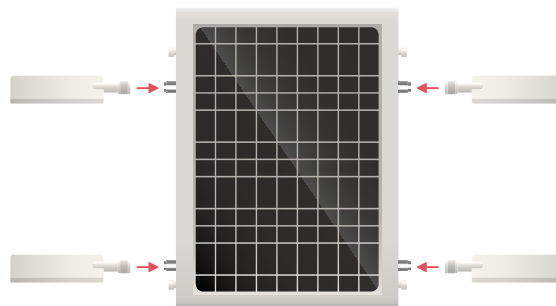

Proceed to programming instructions on page 8.



Installation (cont.)

Installation: Pole Mount

Note: It is recommended that two people work together to complete pole mount installations.

Hook the arms of the pole mount into the ears of the NextLink.

Loosely attach the arms to the ears with two (2) M8x18mm screws.

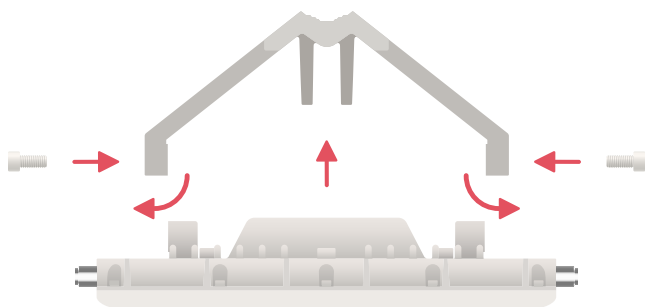

Attach one end of the pivot bar to the pole mount using the M8x50mm bolt and M8 locknut (see item A in the illustration below).

Attach the opposite end of the pivot bar to the NextLink (see item B in the illustration below). Choose the appropriate set of holes in the center of the NextLink to optimize the angle of the solar panel (relative to the sun). Use the M8x45mm bolt and M8 locknut.

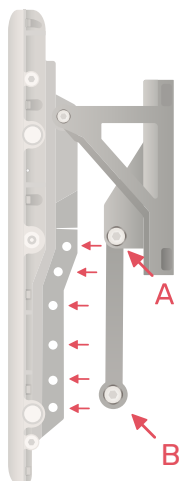

Once the appropriate angle is achieved, use a wrench to tighten all bolts connecting the NextLink and mounting hardware well beyond hand tight to ensure a secure connection. Do not use excessive force, which can result in over-tightening.

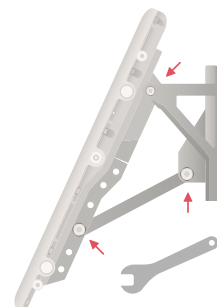

To connect pole mount to the pole, slide the band clamps through the slots at the top and bottom of the pole mount, then around the pole.

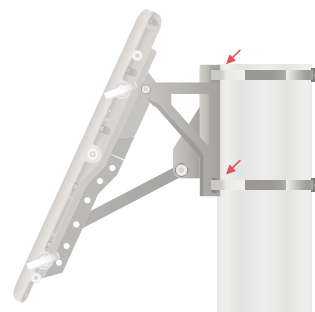

Fasten the band clamps around the pole. One person should hold the NextLink in place as the other tightens the band clamps around the pole.

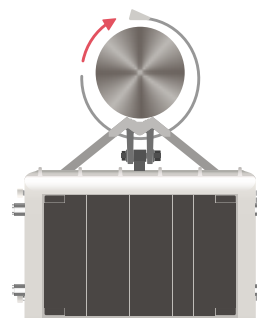

Important: Install the band clamps to no more than 18 lbs of torque. Do not overtighten. Do not use an impact driver to tighten. Overtightening can compromise installation integrity.



Installation (cont.)

Attach the safety cable to a solid mounting point near the NextLink. Then remove one of the M8x18mm screws and use it to bolt the end of the safety cable to the mount bracket and the NextLink.

If no solid mounting point is available, you can loop the safety cable around the pole before securing it to the NextLink.

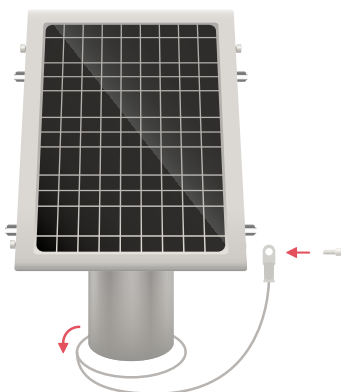

Attach the antennas by hand tightening them to the connection points on the sides of the NextLink. Any antenna can be connected to any connection point.

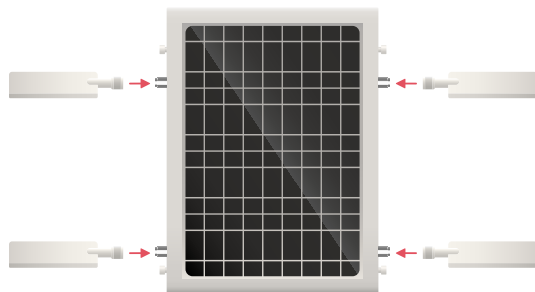

Proceed to programming instructions on page 8.

Installation: Flat Mount

Using the flat mount side of the included drilling template, mark the holes for the mounting hardware on the surface where the device will be mounted.

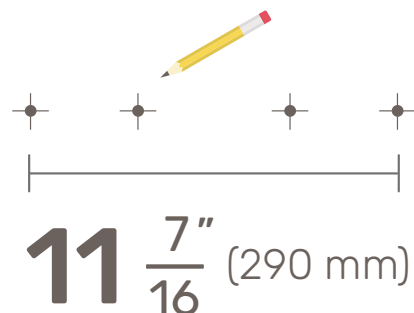

Drill the holes using a 1/4" drill bit.

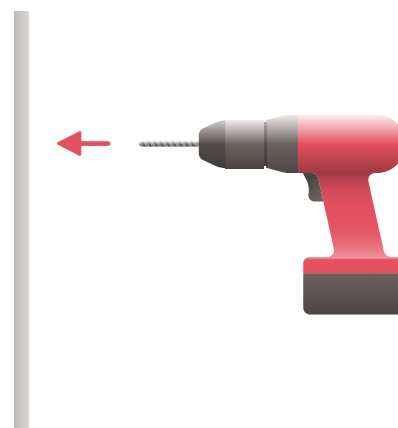

Using the holes drilled in the previous step, attach the brackets to the surface using eight (8) M8x30mm lag bolts and washers. You will use four (4) bolts/washers per bracket.

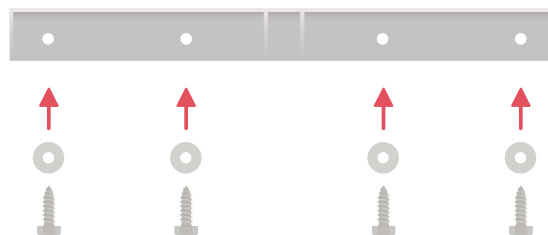



Installation (cont.)

Attach the NextLink to the mounts using four (4) M8x18mm socket head cap screws.

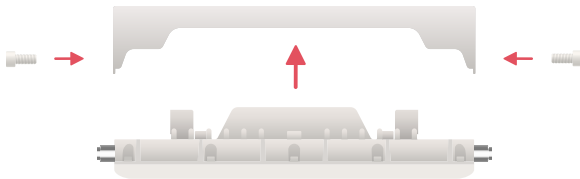

Attach the safety cable to a solid mounting point near the NextLink. Depending on your installation location, you may need to loop the cable through itself around a mounting point.

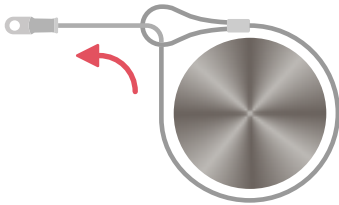

Remove one of the M8x18mm screws and use it to bolt the end of the safety cable to the mount bracket and the NextLink.

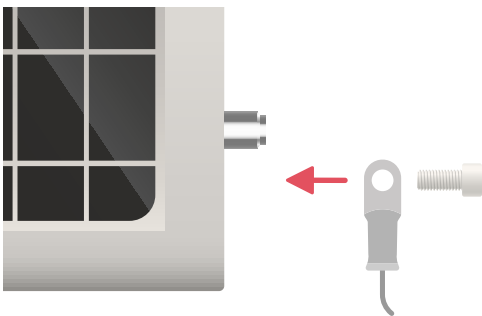

Attach the antennas by hand tightening them to the connection points on the sides of the NextLink. Any antenna can be connected to any connection point.

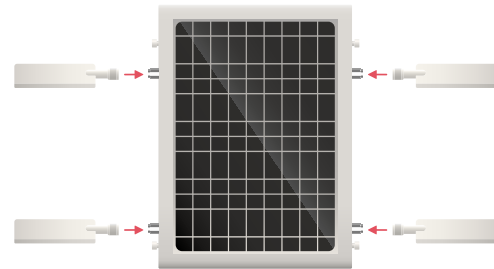

Proceed to programming instructions on page 8.

Specifications & Installation Guide



Programming and Additional Information

Programming & Verification

Programming is the process of associating the NextLink's serial number with the property where it is installed. This ensures it can communicate with the NextCity Cloud.

To quickly program a large number of devices at once, you can use the CSV file uploader tool on the NextCity web portal. The web portal also offers a rapid programming interface to program additional devices later on.

The NextCity mobile app is ideal for on-site programming and verification.



After logging in to the app or web platform, select or create the property that corresponds to the NextLink.

On the mobile app, tap "Program NextLink".

On the web platform, select "Equipment", then "Network" (located in the top right corner).

Program the NextLink by entering its serial number. You can also scan the device barcode (located on the back of the NextLink) using the barcode scanner in the mobile app.

Wave a magnet below the antenna on the upper right-hand side to verify communication with the network. Two green LED blinks indicate successful connectivity.

If no confirmation is received, relocate the NextLink or add additional NextLinks as needed.

LED Status Information

You can check the NextLink's current battery status by viewing the LED on the device. When a magnet is held by the device's battery indicator LED (located just below the antenna on the upper right-hand side of the device), it will light up to indicate the device's current battery.

 **FULL BATTERY**

 **LOW BATTERY**

 **VERY LOW** (Radios are turned off)

Current battery levels can also be checked in the NCSS mobile app or on the NextCentury web platform.

Long-Term Battery Information

The NextLink's field-replaceable battery has a lifespan of 7-10 years. You will receive alerts within the NCSS app starting several months before the battery needs to be replaced.